

Induction Coil Magnetometers

LEMI-118
LEMI-120
LEMI-121
LEMI-123
LEMI-134

Fluxgate Magnetometers

LEMI-011
LEMI-018
LEMI-019
LEMI-022
LEMI-024
LEMI-025
LEMI-029
LEMI-031

Electrodes & E-field Measurements

LEMI-701

Magnetic and Magnetotelluric Stations

LEMI-030
LEMI-417
LEMI-418

Calibration Systems

LEMI-901
LEMI-931

Special Products

LEMI-017
LEMI-204
LEMI-301

Product description

LEMI-024 is an analog three-component fluxgate magnetometer with two sets of outputs. The low-sensitivity unfiltered output is capable of monitoring the magnetic field intensity to the full range of the earth magnetic field in the frequency range from DC to 500 Hz. The additional high-sensitivity filtered output is used to measure weak magnetic fluctuations in the frequency band from 0.003 Hz to 10 Hz. The LEMI-024 features low noise levels, extended temperature range of operations and low power consumption.

Application description

LEMI-024 can be used in geomagnetic or magnetotelluric applications as well as in monitoring and field compensation applications. Due to its dual output design the full scale earth magnetic field and weak field variations can be measured. Both outputs can be used simultaneously in high accuracy compensation circuits.

Highlights

- High sensitivity filtered output
- Noise $\leq 6\text{pT}/\sqrt{\text{Hz}}$ @ 1 Hz
- High stability at low frequencies
- Power consumption $\leq 350\text{ mW}$
- Extended temperature range

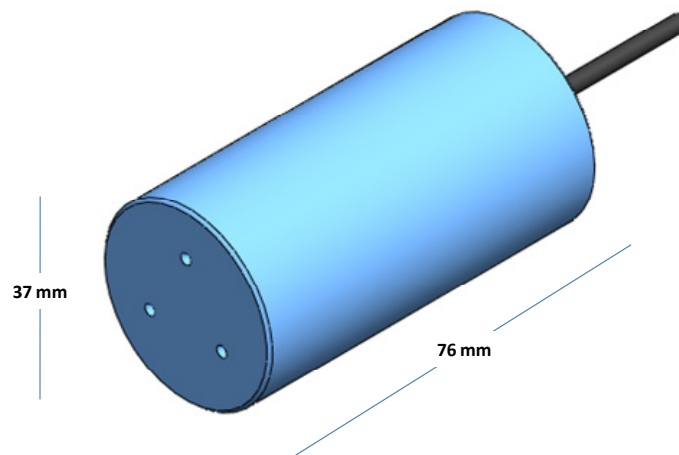

LEMI-024 dimensional drawing



Mail:

LEMI Laboratory for Electromagnetic Innovation
5-A Naukova Street
Lviv, 79000, Ukraine

Internet:

Web – www.lemisensors.com
Email – sales@lemisensors.com

Phone:

 + 001 713 532 8144
 + 049 221 95279794
 + 380 322 639163



LEMI-024 Fluxgate Magnetometer

Specifications

Sensor elements	3 orthogonal elements
Length	76 mm (sensor)
Diameter	37 mm (sensor)
Weight	< 115 g (sensor)
Dynamic range of unfiltered signal	$\pm 80,000$ nT
Dynamic range of filtered signal	$\pm 10,000$ nT
Frequency range of unfiltered signal	DC to 500 Hz
Frequency range of unfiltered signal	0.003 Hz to 10 Hz
Transformation factor of unfiltered output	0.056 mV/nT
Transformation factor of filtered output	0.448 mV/nT
Transformation coefficient error	$\pm 3\%$
Noise level @ 1 Hz	≤ 6 pT/ $\sqrt{\text{Hz}}$
Noise rejection @ 50 Hz (filtered output)	≥ 40 dB
Temperature rating	0°C to +70°C
Construction material	Syntactic foam
Power consumption @ 9V	≤ 350 mW
Power supply voltage	$\pm 12 (\pm 1)$ V

Noise level

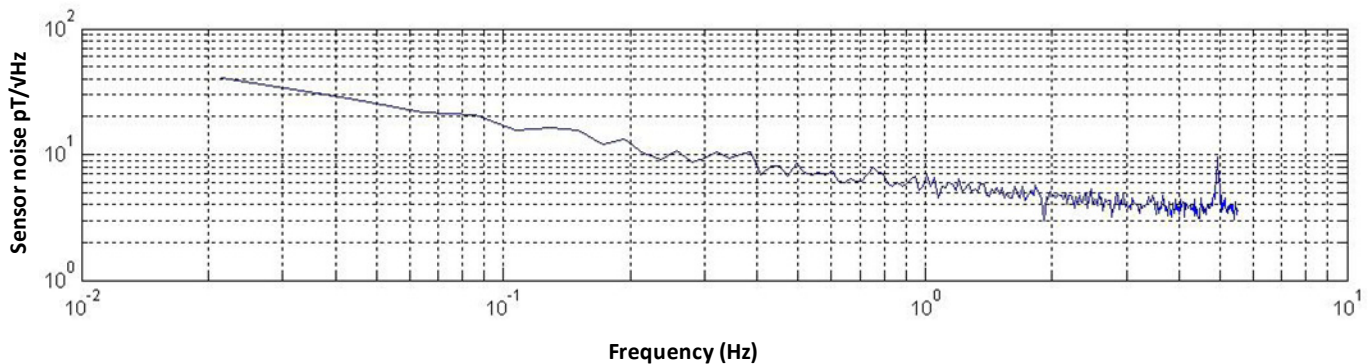

Noise density spectrum of the LEMI-024 Fluxgate Magnetometer



Mail:

LEMI Laboratory for Electromagnetic Innovation
5-A Naukova Street
Lviv, 79000, Ukraine

Internet:

Web – www.lemisensors.com
Email – sales@lemisensors.com

Phone:

 + 001 713 532 8144
 + 049 221 95279794
 + 380 322 639163